

EVoline® Wing

Datenblatt / Data Sheet

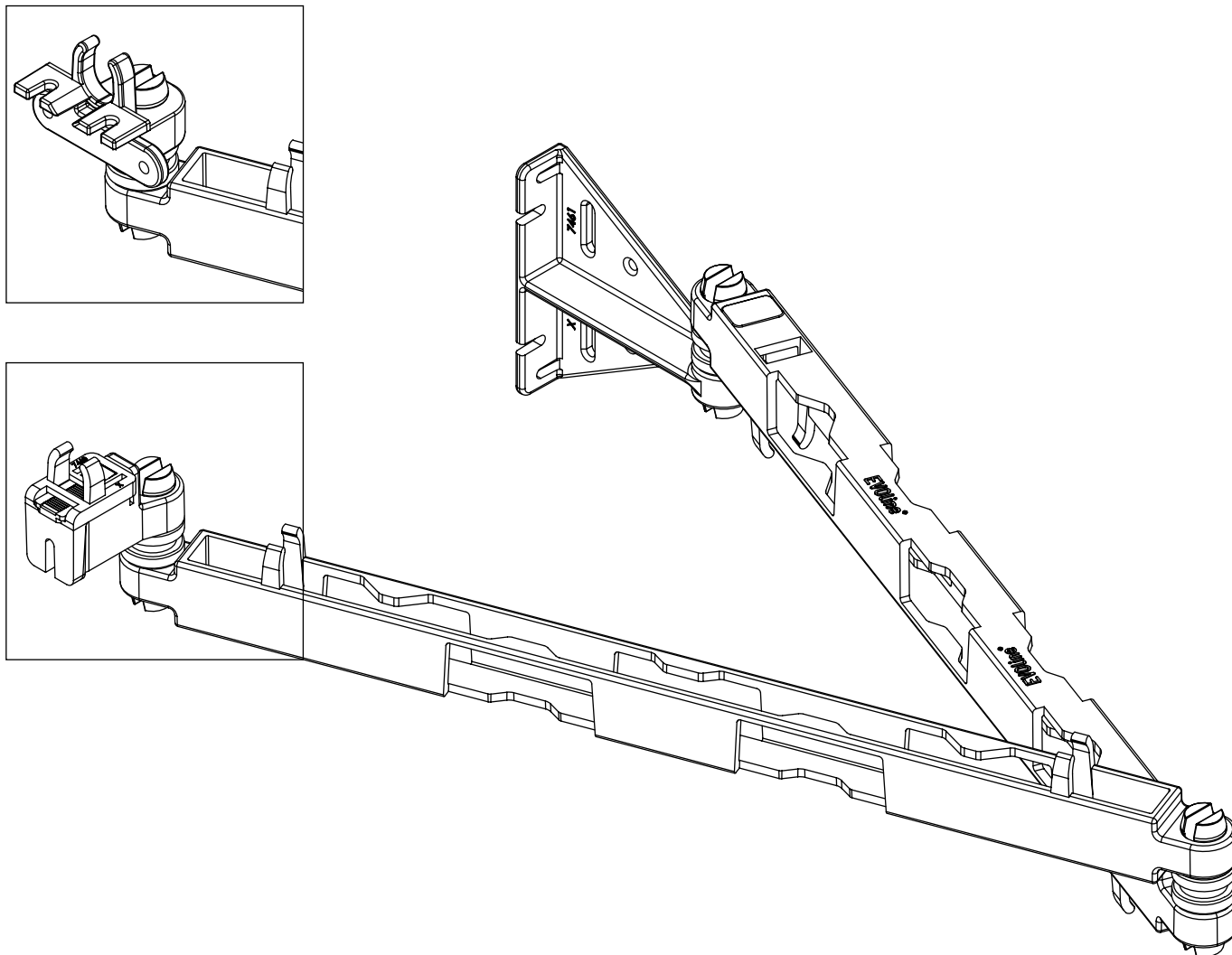

Schulte Elektrotechnik GmbH & Co KG

Jüngerstraße 21
58515 Lüdenscheid

Telefon +49 23 51 / 94 81 - 0
Fax +49 23 51 / 4 26 58

E-Mail info@schulte.com
Internet www.evoline.com

Stand 07/2022

Technische Änderungen
vorbehalten

*Technical changes
reserved*

EVoline® Wing

Datenblatt / Data Sheet

Einsatzbereich Area of application

- Schubladen mit Holz- oder Metallrückwand

Drawers with wooden or metal back panel

Lieferbare Oberflächen Available finishes

- Kunststoff schwarz

Plastic black

Sonstiges Further

- Mit zwei Adaptern für Holz- und Metallrückwände

With two adapters for wooden and metal back panels

Einzelteile Individual parts

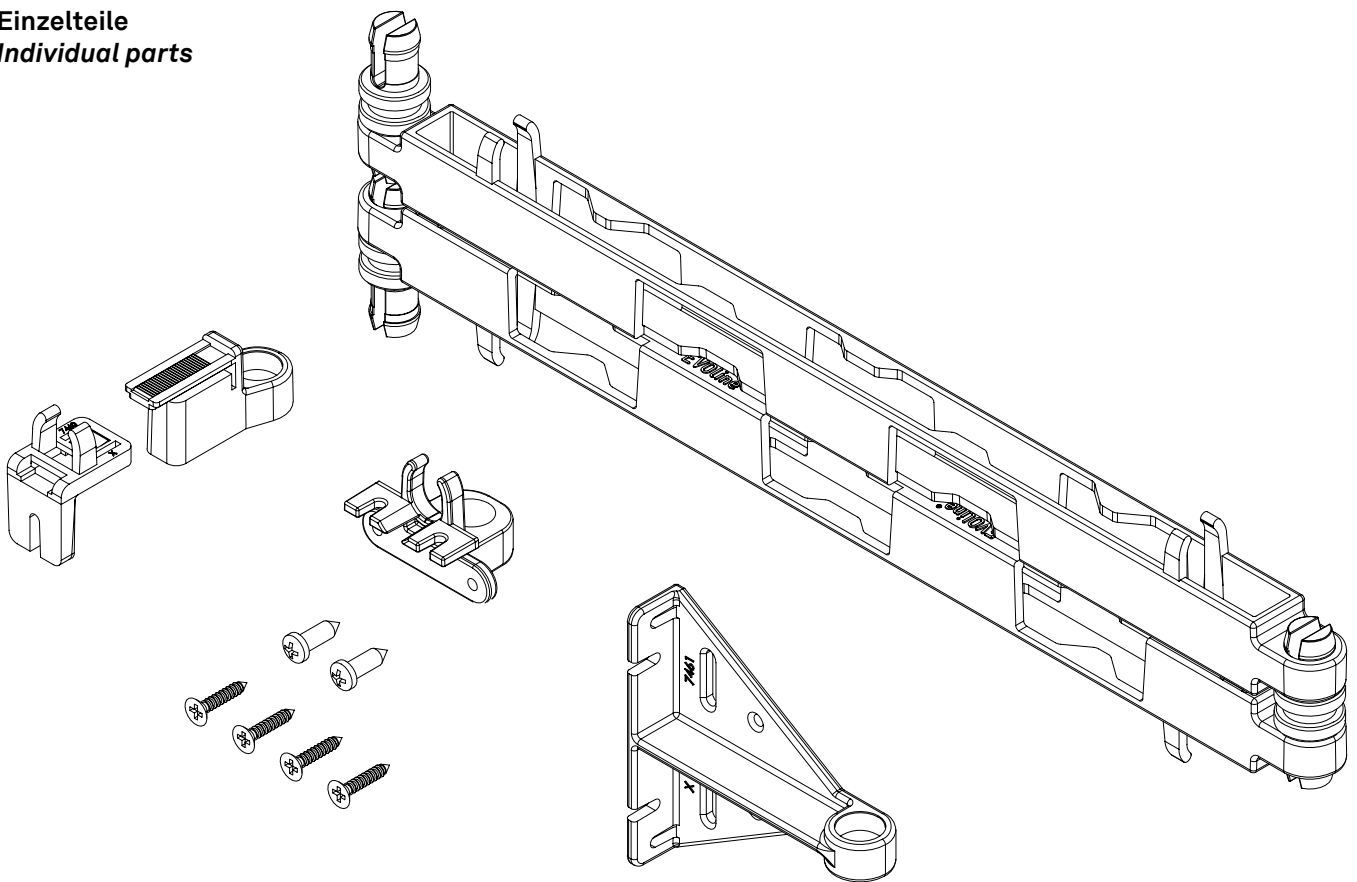

EVoline® Wing

Datenblatt / Data Sheet

Maße (Adapter: Holz- oder Metallrückwand)
Dimensions (adapter: wooden or metal back panel)

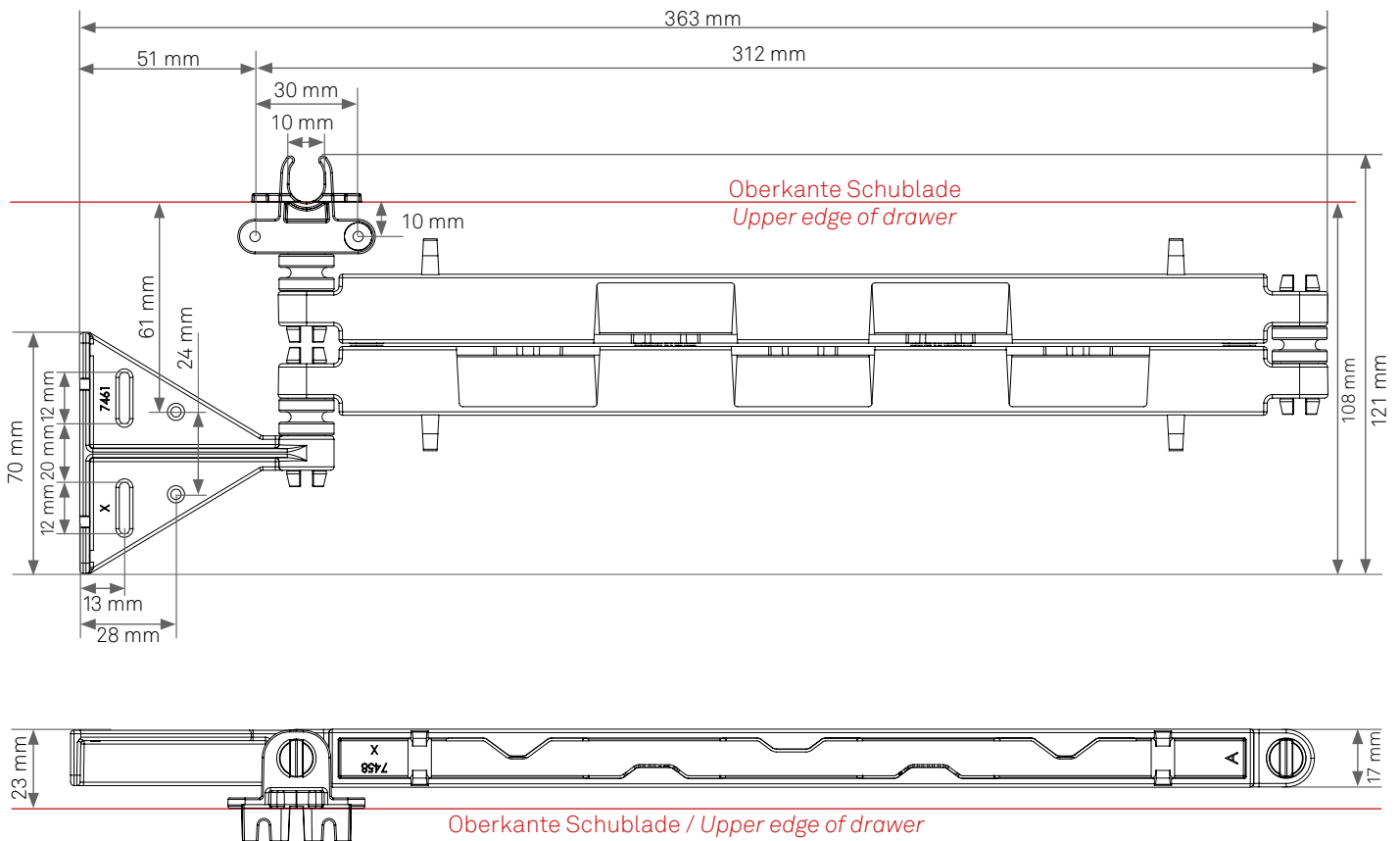
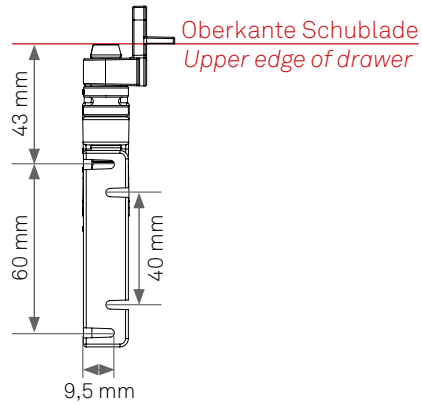
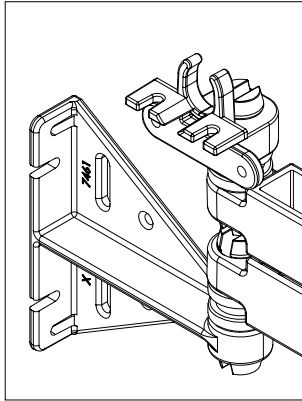

EVoline® Wing

Datenblatt / Data Sheet

Maße (Adapter: Metallrückwand)
Dimensions (adapter: metal rear panel)

